

Data Sheet



Article number: 021500700074

Description: Sealing Clamp S 74 W5

Measures

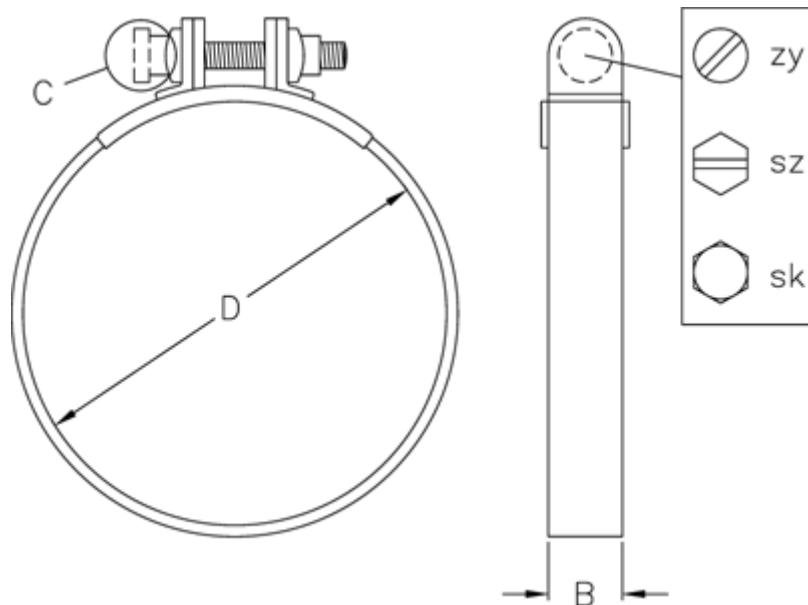

C (screw type) = SZ

Diameter D = 74

Width B = 20